

Edition 2.0



SQUIX
Made in Germany

Contents

Label printers SQUIX for industrial application3
Type overview SQUIX 44
Technical details5
Operation panel6
Print heads7
Print rollers7
Interfaces.7
Technical data8-9
Accessories	10-13
Applicator S1000	14-15
Applicator S3200	16
Dispensing module S5104	16
Mounting equipment SQUIX 4	17
Software	18
Stand-alone operation.	18
Printer drivers	19
Programming / Integration / Administration	19
Maintenance / Service / Training	20
Product range	21-22
Product overview	23

All information on scopes of delivery, design and technical specifications correspond to the date of the printing. Subject to change.

For current data see website www.cab.de/en/squix

Label printers SQUIX for industrial application



SQUIX are the further development of the successful A+ printers.

SQUIX represent

- innovative technology,
- easy operation,
- accuracy of impression,
- reliable and fast printing,
- compact, appealing design,
- highest quality standards.

The professional industrial label printers SQUIX can be used in a wide variety of applications. Their development is foremost focused on simple and convenient operation coupled with high reliability.

The print mechanics and housings are made of high-quality materials and perfectly match in terms of shape and function. A wide range of peripherals and software enable specific customized solutions.

Regardless of whether they are operated in stand-alone mode, in a PC application or in a network – the solid SQUIX printers are always up to the mark. A high-speed processor ensures fast printing processes and immediate label output.

Sample applications:

PCB labels

If there is only little space available – smallest label size 4 x 4 mm



Type plates

Pin sharp 600 dpi fonts, graphics and barcodes



Cardboard box and pallet labels

Labels up to A6 format



Type overview

SQUIX 4

Material guide left-aligned



1.1 Basic versions

For printing on labels and continuous materials, wound on rolls or fanfold. The material is torn off at the jagged tear-off edge. Optionally, it can be cut or externally rewound.

1.2 Dispensing versions P

In addition to the basic model the labels can be dispensed. The label is removed from the liner during the printing process. It can be removed manually or by applicator.

Delivery includes I/O interface

Material guide centered



1.3 Basic versions M

For printing on all materials that are wound on rolls or reels resp. fanfold. Especially for very small labels and slim continuous materials such as pressed tubes. There is no need of adjusting the label width on the print head. For small materials adapted print rollers are offered.

1.4 Dispensing versions MP

In addition to the basic model the labels can be dispensed. The label is removed from the liner during the printing process. It can be removed manually or by applicator.

Delivery includes I/O interface



With RFID write/read device in preparation

1.5 HF according to ISO/IEC 15693 with 13.56 MHz

1.6 UHF according to ISO/IEC 18000-6C/EPC Class 1 Gen 2

When using Smart Labels, the integrated RFID chips are tested and qualified with data before printing. In case of an error the label is marked. To get good results in both writing and reading even when small labels are processed, the antenna position is centered just above the transponder.



1.7 Basic versions with separator MT

for continuous textile materials

Because of high heat energy while printing and the electrostatic charge of the materials the ribbon may stick with the textile tape. A separator guarantees reliable separation. It is recommended to select the print roller according to the maximum width of the textile tape resp. ribbon.

Technical details



*Label printer
SQIX 4 MP*

1 Hinged cover

The two-part cover made of impact-proof plastics folds when opened. Only little footprint is needed. The large panoramic window allows to check the consumption of material and track the full printing process.

2 Solid metal chassis

Made of cast aluminum. All components are mounted on it.

3 Peel-off function

The label is removed from its liner via peel-off plate. High accuracy of printing and applying is achieved with the powered rewind assist and pinch rollers.

4 Peripheral connection

Add-on modules are easy to connect. All peripheral devices are plugged in the printer with two pins and fixed with a screw.

5 Ribbon holder

The three-part tightening axles enable a quick and easy exchange of ribbon.

6 Roll holder

The spring-mounted margin stop ensures constant tension during material feed, thus high accuracy of printing. For heavy rolls with core diameters of 76 or 100 mm an adapter is recommended.

7 Internal rewinder

With the rewinder labels or liners with or without a cardboard core can be rewound. The three-part tightening axle allows easy removal of the material.

8 Rocker

The resilient rocker with pulleys made of Teflon dampens the tension at print start, thus improving the accuracy of impression.







Operation panel

Intuitive and easy operation with self-explanatory symbols for configuration of the printer settings

Display

- 1 Power on
- 2 **Headline**
These functions are displayed:
receive print data, record data stream, ribbon warning, USB memory stick, SD memory card, USB, LAN, WLAN, Bluetooth, time
- 3 **Status reports**
Ready, pause, number of printed label per print job, label in dispensing position, waiting for external start signal

Buttons

- 4  For **options** with the following functions
Cutter/perforation cutter: direct cutting
External rewinder: winding inside and outside
Tear-off or peel-off mode: printing of the next label
Applicator: application of the label
- 5 **Operation**
 -  Jump to menu
 -  Repetition of the last label
 -  Interruption and continuation of the print job
 -  Stop and deletion of all print jobs
 -  Label feed

USB plug-in / USB WLAN stick

- 6 For the **service key** or a **memory stick**, to load data into the IFFS storage
- 7 **USB WLAN stick** 802.11b/g/n 2.4 GHz included as an extra item in the scope of delivery



Example: Print head settings



Menu selection



Setup options



Printing parameters



Print speed with scroll function

Print position Y slide control for fast adjustment ± keys for fine adjustment

Print heads



All print heads are automatically detected and calibrated by the CPU. Major data like running performance, maximum operating temperature and heating energy are stored directly in the print head. The data can be read out at the plant.

Print heads type 4 - 300, 600 dpi

With a particularly sharp-edge print image;
They are suitable for type plates with small fonts and graphics.
They are, amongst others, required for resin ribbons with high energy needs.

Print heads type 4.3 - 200, 300 dpi

They are recommended especially for direct thermal printing and application in rough surroundings.

Print rollers



Two types of material are provided for the different applications:

Print rollers DR4 – synthetic rubber coating;
They are suitable for high accuracy of impression and are provided as standard.

Print rollers DR4 M25/50/80 – synthetic rubber coating;
In the case of centered material guidance slim print rollers are needed for slim materials and ribbons. In this way, wear of print rollers, contamination of print heads and errors in material feed are avoided.

Print rollers DRS4 – silicone rubber coating;
They have an extra long service life with a higher tolerance of impression.

Interfaces

on the back of the device

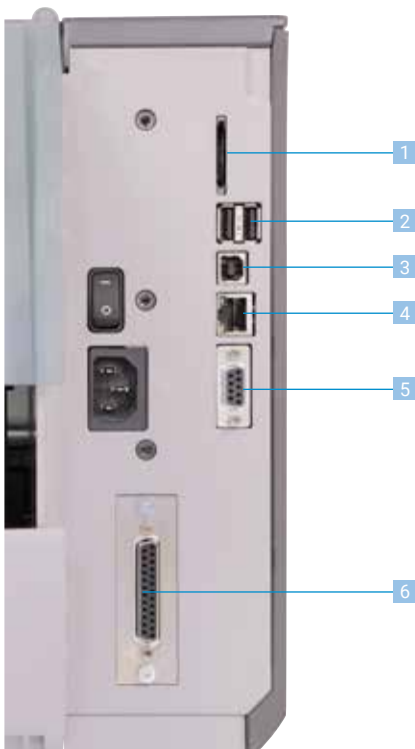

1 Plug-in for SD memory card

2 2 x USB host interfaces

for keyboard, barcode scanner, USB memory stick, USB Bluetooth adapter

3 USB 2.0 Hi-speed device for PC connection

4 Ethernet 10/100 BASE-T

5 RS232C interface 1.200 to 230.400 baud/8 bit

6 3.1 I/O interface standard with dispensing device, accessory to basic device
A PLC, a sensor or a hand switch start the labeling. At the same time, status and error messages are issued.

Compliant with IEC/EN 61131-2, type 1+3;
all in- and outputs with galvanic isolation and reverse polarity protection,
outputs in addition short circuit protected

Inputs PNP

Start printing and applying
Print first label
Reprint
Delete print job
Label dispensed
Interrupt labeling
Pause
Reset

Outputs PNP, NPN on request

Printer/applicator ready
Print job available
Applicator in basic position
Paper feed ON
Label in dispensing position
Applicator in applying position
Pre-warning end of ribbon
Common error

Technical data

● Typical ○ Possible ■ Standard □ Option

Device type		Material guide		Left-aligned				Centered			
Type of print head				4.3	4.3	4	4	4.3	4.3	4	4
Printing method	Thermal transfer			●	●	●	●	●	●	●	●
	Direct thermal			●	●	○	○	●	●	○	○
Printable resolution		dpi		203	300	300	600	203	300	300	600
Print speed			up to mm/s	250	250	300	150	250	250	300	150
Print width			mm	104	108.4	105.7	105.7	104	108.4	105.7	105.7
Printable area	Distance to locating edge	when left-aligned	mm	2.8	1.2	2.0	2.0	-	-	-	-
		when centered	mm					Centered on material			
Material¹⁾											
On roll or fanfold:	paper, cardboard, ready-for-use tubes, plastics PET, PE, PP, PI, PVC, PU, acrylate, Tyvec			●				●			
On roll, reel or fanfold:	pressed continuous tubes, textile, Smart Labels			-				●			
Labels	Width ²⁾	mm		20 - 116				4 - 110			
	Height ¹⁾	mm		6 - 2,000				4 - 2,000			
	Thickness	mm		0.03 - 0.60				0.03 - 0.60			
Liner material	Width	mm		24 - 120				9 - 114			
	Thickness	mm		0.03 - 0.13				0.03 - 0.13			
Continuous material	Width	mm		24 - 120				4 - 114			
	Thickness	mm		0.05 - 0.50				0.05 - 0.50			
	Weight (cardboard)	up to g/m ²		300				300			
Pressed tube	Width ready-for-use	up to mm		120				114			
	Width continuous	mm		-				4 - 85			
	Thickness	up to mm		1.1				1.1			
Roll	Outer diameter	up to mm		205				205			
	Core diameter	mm		38.1 - 100				38.1 - 100			
Reel	Outer diameter	up to mm		-				205			
	Core diameter	mm		-				38.1 - 76			
	Outer width	mm		-				11 - 114			
Winding				Outside or inside				Outside or inside			
Ribbon²⁾											
Ink side				Outside or inside							
Roll diameter		up to mm		80							
Core diameter		mm		25.4							
Variable length		up to m		450							
Width ²⁾		up to mm		25 - 114							
Internal rewinder with dispensing device											
Outer diameter		up to mm		142							
Core diameter		mm		38.1 - 40							
Winding				Outside							
Printer sizes and weight											
Width x Height x Depth		mm		252 x 288 x 460							
Weight		kg		10							
Label sensor with position indication											
Gap sensor				For label front edge or punch marks and end of material							
Reflective sensor from below or top				For print mark front edge and end of material							
Distance sensor	to locating edge	Left-aligned	mm	5 - 60				-			
	from center to locating edge	Centered	mm	-				0 - 55			
Height of material passage		mm		2				2			
RFID											
Write/read device	HF	ISO/IEC 15693, 13,56 MHz		-				□			
	UHF	ISO/IEC 18000-6C/EPC Class 1 Gen 2		-				□			
Electronics											
Processor 32 bit clock rate		MHz		800							
Main storage (RAM)		MB		256							
Data storage (IFFS)		MB		50							
Plug-in for SD memory card (SDHC, SDXC)		up to GB		512							
Battery for time and date, real-time clock				■							
Data storage when power turned off (e. g. serial numbers)				■							
USB WLAN stick 802.11b/g/n 2.4 GHz				■ (included as extra item in scope of delivery)							
Interfaces											
RS232C 1.200 to 230.400 baud/8 bit				■							
USB 2.0 Hi-speed Device for PC connection				■							
Ethernet 10/100 BASE-T				LPD, IPv4, IPv6, RawIP printing, DHCP, HTTP, FTP, SMTP, SNMP, TIME, NTP, Zeroconf, SOAP web service							
1 x USB host at the operation panel for				Service key or USB memory stick							
1 x USB host at the operation panel for				USB WLAN stick 802.11b/g/n 2.4 GHz							
2 x USB host on the back of the device for				Keyboard, barcode scanner, USB memory stick, USB Bluetooth adapter, USB WLAN stick 802.11b/g/n 2.4 GHz + a/n/ac 5 GHz with rod antenna							
WLAN 802.11b, g, n, access point or station mode		GHz		2,4 ■ / 5 □							
Peripheral connection USB host, 24 DC				■							
Digital I/O with 8 in- and outputs			Dispensing/basic device	■/□							

¹⁾ Limitations may apply to small labels, thin materials or strong adhesives. These applications need to be tested and approved.

Operating data	
Power supply	100 - 240 VAC ~ 50/60 Hz, PFC
Power consumption	Standby < 10 W / typical 150 W / maximum 300 W
Temperature / Operation	0 - 40°C / 10 - 85% not condensing
humidity	Storage 0 - 60°C / 20 - 85% not condensing
Transport	-25 - 60°C / 20 - 85% not condensing
Approvals	CE, FCC class A, CB, CCC, cUL
Operation panel	
	Touchscreen LCD color display
Screen diagonal	4.3"
Pixel W x H	272 x 480
Settings	
	Region: Time/date languages Labels country Ribbon keyboard Error handling time zone Interpreter/emulation Print Interfaces Dispense Cut Apply
On display	
	Digital clock USB slave status Data reception Ribbon remaining WLAN field intensity USB memory stick Ethernet status plugged in Bluetooth status SD memory card Data recording plugged in
Control	
	Ribbon direction of winding Print head tension Ribbon pre-warning Print head temperature End of ribbon Print head open End of material Pinch roller open Peripheral error (with dispensing version and separator)
Testing	
System diagnosis	When device is switched on, including automatic print head detection
Information display, status printout, analysis	List of fonts, list of devices, WLAN status, label profile, test grid, monitor mode, print data recorded on memory card
Status reports	Printout of device settings, e. g. print length and runtime counter, machine status via software command, display of e. g. network errors - no link, barcode error, peripheral error etc.
Fonts	
Font types	5 bitmap fonts including OCR-A, OCR-B and 3 vector fonts Swiss 721, Swiss 721 bold and monospace 821 internally provided, TrueType fonts loadable
Character sets	Windows 1250 to 1257, DOS 437, 737, 775, 850, 852, 857, 862, 864, 866, 869, EBC DIC 500, ISO 8859-1 to -10 and -13 to -16, WinOEM 720, UTF-8, Macintosh Roman, DEC MCS, KOI8-R All Western and Eastern European characters, Latin, Cyrillic, Greek, Hebrew, Arabic, simplified Chinese and Thai characters are supported.
Bitmap fonts	Size in width and height 1 - 3 mm Zoom factor 2 - 10 Orientation 0°, 90°, 180°, 270°
Vector/ TrueType fonts	Size in width and height 0,9 - 128 mm Zoom factor freely adjustable Orientation 360° in steps of 1°
Font styles	Bold, italic, underlined, outline, inverse - depending on the font type
Character pitch	Variable or monospace for steady character pitches

Graphics	
Graphic elements	Lines, arrows, rectangles, circles, ellipses, filled and filled with fading
Graphic formats	PCX, IMG, BMP, TIF, MAC, GIF, PNG
Barcodes	
Linear barcodes	Code 39, Code 93 Interleaved 2/5 Code 39 Full ASCII Ident and lead code of Code 128 A, B, C Deutsche Post AG EAN 8, 13 Codabar EAN/UCC 128/GS1-128 JAN 8, 13 EAN/UPC appendix 2 MSI EAN/UPC appendix 5 Plessey FIM Postnet HIBC RSS 14 UPC A, E, E0
2D and stacked codes	Aztec Codablock F DataMatrix PDF417 Micro PDF417 UPS MaxiCode QR code RSS 14 truncated, limited, stacked and stacked omnidirectional EAN/GS1 DataMatrix GS1 DataBar All codes are flexible in height, modular width and ratio. Orientation 0°, 90°, 180°, 270° Options: check numbers, plain writing printout and start/stop code depending on type of code
Software	
Programming	Direct programming with printer language JScript abc Basic Compiler Database Connector
Emulation	ZPL
Control/ administration	Printer control Administration Network Manager
Label software	cablabel S3 Lite cablabel S3 Viewer cablabel S3 Pro cablabel S3 Print
Also running with	CODESOFT NiceLabel EASYLABEL BarTender
WHQL certified Windows printer drivers for	Windows Vista Server 2003 Windows 7 Server 2008 Windows 8 Server 2008 R2 Windows 8.1 Server 2012 Windows 10 Server 2012 R2
Apple Mac drivers	OS X printer drivers valid from version 10.6
Linux drivers	Valid from CUPS 1.2
Stand-alone operation	

● Typical ○ Possible □ Accessory

Pos.	Printer add-ons	Basic device	Dispensing device	Left-aligned	Centered	
1.5	RFID HF 13,56 MHz	●	●	-	□	
1.6	RFID UHF 868/915 MHz	●	●	-	□	
1.7	Separator S400	●	-	-	□	
Extra equipment						
2.2	Print rollers DR4-M25, DR4-M50, DR4-M80	●	●	-	□	
	Print roller DRS4	●	●	□	□	
2.3	Antistatic brush	●	●	□	□	
2.6	Adapter 100	●	●	□	□	
2.7	SD memory card 8 GB	●	●	□	□	
2.8	USB memory stick 8 GB	●	●	□	□	
2.9	USB WLAN stick 802.11b/g/n 2.4 GHz + a/n/ac 5 GHz	●	●	□	□	
2.10	USB Bluetooth adapter	●	●	□	□	
2.11	Barcode tester for linear and 2D barcodes	●	●	□	□	
Dispensing labels						
2.12	Present sensor PS800	-	●	□	-	
2.13	Present sensor PS900	-	●	□	□	
2.14	Present sensor PS1000	-	●	-	□	
2.15	Extended peel-off plate DP410	-	●	□	□	
2.16	Product sensor	-	●	□	□	
Interfaces						
3.1	I/O interface	●	●	□	□	
3.2	I/O interface connector, SUB-D 25 pin	●	●	□	□	
3.3	Label selection - I/O box	●	●	□	□	
Connecting cable						
4.1	Connecting cable RS232 C, 9/9 pin, length 3 m	●	●	□	□	
Cutting, perforating, stacking						
5.1	Cutter CU400 with cutter tray	●	○	□	□	
5.2	Perforation cutter PCU400	●	○	□	□	
5.3	Stacker with cutter and base frame ST400	●	○	-	□	
Rewinding, unwinding labels						
6.1	Rewind guide plate RG400	-	●	□	□	
6.2	External rewinder ER4200	●	○	□	○	
6.3	External rewinder ER4300	●	○	□	○	
6.4	External rewinder EU4390	●	●	□	○	
Applicators and modules for dispensing						
7.1-7.5	Applicator S1000	-	●	□	□	
7.6	All-around labeler	-	●	□	□	
7.7-7.9	Applicator S3200	-	●	□	□	
7.10	Dispensing module S5104	-	●	□	-	
Mounting equipment						
8.1	Mounting plate	-	●	□	-	
8.2	Profile 40/80/120 mm	-	●	□	-	
8.3	Base plate 500 x 255 mm	-	●	□	-	
8.4	Floor stand 1600	-	●	□	-	
8.5	Printer holder	-	●	□	-	
Further A+ series accessories						Part no.
	External rewinder ER1/210 ¹⁾	●	○	□	-	5948102.597
	External rewinder ER4/210	●	○	□	-	5948100
	External rewinder ER4/300	●	○	□	-	5946090
	External unwinder EU4/300	●	●	□	-	5946091
	Adapter kit for rewinders and unwinders ¹⁾	●	●	□	-	5978943
	Peel-off adapter PS5	-	●	□	-	5946120
	Present sensor PS6	-	●	□	-	5942353
	Pause adapter PS7	●	-	□	□	5946146
	Applicator A1000-220 ¹⁾	-	●	□	-	5949001.597
	Applicator A1000-300 ¹⁾	-	●	□	-	5949002.597
	Applicator A1000-400 ¹⁾	-	●	□	-	5949003.597
	Applicator A3200 ¹⁾	-	●	□	-	5976050.597
	Interface connector, SUB-D 15 pin	-	●	□	-	5917652
	Hand switch TR1 ²⁾	-	●	□	-	5942345
	Foot switch ²⁾	-	●	□	-	5535901
	Product sensor ²⁾	-	●	□	□	5941526
	Adapter screw M6/M4 ¹⁾ SQUIX M6 to A4+/M4	●	●	□	□	5977586.001

¹⁾ Adjusted to SQUIX. Adapter screw M6 on M4 to attach the external rewinder ER1/210, the applicators A1000 and A3200

²⁾ To be connected to PS5, PS6, PS7, A1000, A3200

Accessories

Extra equipment	
2.2	 <p>Print roller DR4-M25 Material width up to 25 mm; synthetic rubber coating for high accuracy of impression</p>
	 <p>Print roller DR4-M50 Material width up to 50 mm; synthetic rubber coating for high accuracy of impression</p>
	 <p>Print roller DR4-M80 Material width up to 80 mm; synthetic rubber coating for high accuracy of impression</p>
	 <p>Print roller DRS4 Material width up to 120 mm</p>
2.3	 <p>Antistatic brush Particularly in case of plastic materials electrostatics is discharged after printing.</p>
2.11	 <p>Barcode tester for linear and 2D barcodes The accuracy of a horizontally and vertically printed barcode is tested by a camera directly after printing. In case of a faulty code the print job is stopped and the label can be removed. The barcode tester can be used in tear-off or dispensing mode or with an external rewinder. For further information see the operator's manual.</p>
Dispensing labels	
2.12	 <p>Present sensor PS800 For dispensing devices with left-aligned material guide. The present sensor detects the label being in dispensing position. After the label has been removed the next label is automatically printed.</p>
2.13	 <p>Present sensor PS900 For dispensing devices with left-aligned or centered material guide for example with circular labels whose trailing edges cannot be detected by the present sensors PS800 or PS1000 MP. After the label has been removed the next label is automatically printed.</p>
2.14	 <p>Present sensor PS1000 For dispensing devices with centered material guide. The present sensor detects the label being in dispensing position. After the label has been removed the next label is automatically printed.</p>
2.15	 <p>Extended peel-off plate DP410 For labels with a strong adhesive or very thick liner material that make its removal difficult. Only in connection with printing on demand button on the operation panel or control signal. A present sensor cannot be used.</p>
2.16	 <p>Product sensor For automatic product detection on the conveyor belt; range 200 mm for the reflective sensor</p>
Interfaces	
3.2	 <p>I/O interface connector, SUB-D 25 pin With screw clamps to connect all control signals to the I/O interface</p>
3.3	 <p>Label selection - I/O box From a master controller like PLC up to 32 different labels can be selected from the memory card. The I/O box allows to realize simple PLC control processes with four in- and outputs via abc programming.</p>
Connecting cable	
4.1	 <p>Connecting cable RS232 C, 9/9 pin, length 3 m</p>

Accessories

5.1



Cutter CU400

To cut paper labels, self-adhesive labels, cardboard, textile or plastic materials as well as pressed tubes.

Cutter tray

Up to approximately 50 labels can be collected in the cutter tray.

Cutter		CU400
Material Width	up to mm	120
Weight cardboard	gr/m ²	60 - 300
Thickness	mm	0.05 - 1.1
Cutting length	mm	> 5
Gap height	up to mm	2.5
Cuts	/min	120
Stop print job if		Final cutter position not reached
Cutter tray		
Label height	up to mm	100

5.2



Perforation cutter PCU400

Continuous materials like textile or pressed tubes are perforated in order to subsequently separate them manually. In addition, the materials can also be cut.

Perforation cutter		PCU400
Material Width	up to mm	85
Weight cardboard	gr/m ²	60 - 300
Thickness	mm	0.05 - 1.1
Cutting length	mm	> 5
Gap height	up to mm	2.5
Cuts	/min	Cutting 120/perforating 150
Stop print job if		Final cutter position not reached
Perforating Web width	mm	0.5
Web distance	mm	2.5 or 10

5.3



Stacker with cutter ST400

Printed materials are cut and stacked. When the maximum stack height is reached, the print job is interrupted. With stiff or curved materials limitations may be possible. We recommend to have such applications tested at our plant. To place the devices on the table in any position.

Stacker with cutter		ST400
Material Width	mm	20 - 100
Weight cardboard	gr/m ²	60 - 300
Thickness	mm	0.05 - 0.8
Cutting length	mm	20 - 150
Gap height	up to mm	1.2
Cuts	/min	120
Stop print job if		Final cutter position not reached, paper jam, cover stacker open, stack height reached
Stack height	up to mm	100



Storage table label W x H

Storage table and protective cover are adapted to the label size. They have to be ordered separately.

Accessories

6.1



6.2



6.3



6.4

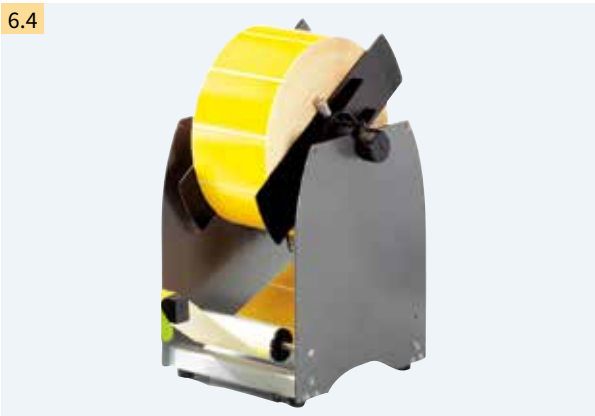

Rewinding labels

with or without a cardboard core

Rewind guide plate RG400 for internal rewriter

Internal rewinding is for dispensing printers.

Thus, the peel-off plate is replaced by the rewind guide plate.

Rewind guide plate		RG400
	Material width	up to mm
	Roll diameter	up to mm
	Tightening axle for core diameter	mm
	Winding	Outside

External rewriter ER4200

The rewriter is screwed with the label printer. Labels are wound either inside or outside. The electronic swing arm control ensures consistent and tight winding.

External rewriter		ER4200
Material width	up to mm	120
Roll diameter	up to mm	205
Tightening axle for core diameter	mm	38.1 - 40
Winding		Outside or inside

External rewriter ER4300

The rewriter is screwed with the label printer. Labels are wound either inside or outside. The electronic swing arm control ensures consistent and tight winding.

External rewriter		ER4300
Material width	up to mm	120
Roll diameter	up to mm	300
Tightening axle for core diameter	mm	76
Winding		Outside or inside

Unwinding labels

External unwinder EU4390

Ensures consistent label feed with heavy rolls.

Both outside or inside wound rolls can be processed.

External unwinder		EU4390
Material width	up to mm	120
Roll diameter	up to mm	390
Core diameter	mm	38.1
	with adapter	mm
		76
Winding		Outside or inside

Applicator S1000

7.1



Real-time labeling

The applicator S1000 combined with a SQUIX is a cost-effective solution for all dispensing printers in semi-automatic operation or when vertically integrated in a production line. The label is placed on the product with a stroke cylinder.

- 1 Long service life**
The ball-bearing guides are low-wearing.
- 2 Flexible product heights**
With the stroke cylinder labeling is possible at different heights. Different stroke lengths are available.
- 3 Compressed air regulation unit**
Micro filters prevent from contamination. The compressed air regulator ensures a permanent high quality of labeling.
- 4 High process reliability**
Supporting air jet stream, induction air and stroke speed are adjustable. For sensitive products and packaging the pressing force can be reduced to less than 10N (1 kg). To avoid contamination, the vacuum holes are cleaned with air pressure after each labeling process.
- 5 Label sizes**
Labels widths from 25 to 176 mm and heights from 25 to 200 mm can be processed.
- 6 Supporting air**
Used for blowing the labels onto the pad

Pre-dispensing button

To test the labeling process. Pushing the button causes the label to be printed and held by the pad. Pushing the button again starts the labeling process.

Applicator		S1000-220	S1000-300	S1000-400
Cylinder stroke	mm	220	300	400
Tamp stroke below device	mm	64	144	244
Compressed air	bar	4.5		

Accessories

7.2



Tamps

The labels are applied to the tamp and held there by vacuum. Tamp and label are then moved to the product by the applicator.

Universal tamp pads

The rasterized vacuum holes are covered by a foil and pierced according to the label size.

Tamp pad

Manufactured according to the label size

Type	Universal tamp pads		Tamp pad	
	A1021	A1021	A1021	M1021
Material guide	Left aligned Centered	Left aligned Centered	Left aligned	Centered
Tamp surface W x H	mm	70 x 60	90 x 90	min. 72 x 60
Label width	mm	25 - 70	25 - 90	25 - 116
Label height	mm	25 - 60	25 - 90	25 - 200
Product surface	Flat			
Product height	Variable			
Product during labeling	Not moving			

Accessories

Applicator S1000



Spring-mounted tamps

The spring deflection allows labeling even on inclined surfaces.

Universal tamp pads

The rasterized vacuum holes are covered by a foil and pierced according to the label size.

Tamp pad Manufactured according to the label size

Type	Universal tamp pads		Tamp pad	
	A1321	A1321	A1321	M1321
Material guide	Left aligned Centered	Left aligned Centered	Left aligned	Centered
Tamp surface W x H	mm 116 x 102	mm 116 x 152	min. 86 x 92	
Label width	mm 25 - 116	mm 25 - 116	25 - 116	
Label height	mm 25 - 102	mm 25 - 152	25 - 200	
Product surface	Flat			
Product height	Variable			
Product during labeling	Not moving			



Blow pad

In case of pressure-sensitive products the label can be blown on.

Thus, the blow pad moves to a fixed height. The product to be printed is positioned about 10 mm below.

Blow pad	A2021	M2021
Material guide	Left aligned	Centered
Tamp surface W x H	mm 72 x 60	
Label width	mm 25 - 116	
Label height	mm 25 - 100	
Product surface	Flat	
Product height	Fixed	
Product during labeling	Not moving or in motion	



Roll-on pad

With the roll-on pad the label is moved right below the roll while printing. The pad moves to the product. The label is taken over by the product and rolled on during transport.

Roll-on pad	A1411
Material guide	Left aligned / Centered
Tamp surface W x H	mm 120 x 80
Label width	mm 25 - 116
Label height	mm 80 - 200
Product surface	Flat
Product height	Variable
Product during labeling	In motion



All-around labeler

With the applicator labels can be applied to cylindrical objects around the entire 360° circumference. The product is put on the rolls and labeling is started via hand or foot switch.

Tamp pad	A1021	M1021
Material guide	Left aligned	Centered
Tamp surface W x H	mm min. 72 x 60	
Label width	mm 25 - 116	
Label height	mm 25 - 140	
Product diameter	mm 12 - 40	
Product surface	Cylindrical	
Product during labeling	In rotary motion	

Applicator S3200

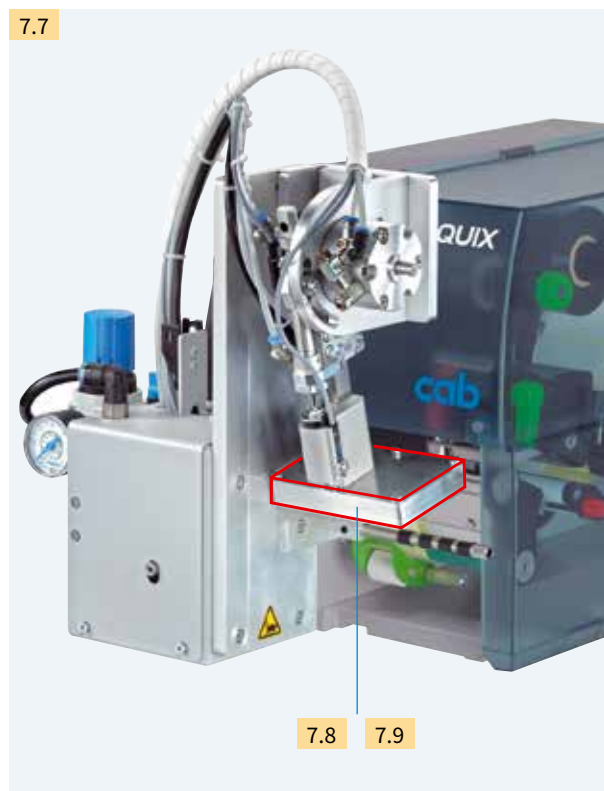

Real-time labeling

The applicator S3200 combined with a SQUIX is a cost-effective solution for all dispensing printers in semi-automatic operation or when vertically integrated in a production line. With the S3200 printed labels are automatically applied on a product. By means of a rotary cylinder the label is positioned 45° to 95° to the horizontal and placed on the product with a short stroke cylinder.

Information on service life, pre-dispensing, compressed air regulation unit, process reliability and supporting air correspond with the applicator S1000 (see page 14).

Applicator	S3200
Rotary cylinder	45° - 95°
Stroke cylinder up to mm	30
Compressed air bar	4.5

Tamp pads or blow pads are manufactured according to the label size.

	Tamp pad		Blow pad	
	A3200-1100	M3200-1100	A3200-2100	M3200-2100
Material guide	Left aligned	Centered	Left aligned	Centered
Tamp surface W x H min. mm	72 x 60		72 x 60	
Label width mm	20 - 116		20 - 116	
Label height mm	5 - 80		10 - 80	
Product surface	Flat			
Product during labeling	Not moving		Not moving or in motion	

Dispensing module S5104



Dispensing module S5104

For labeling on packaging on a conveyor belt. The product sensor identifies the labeling position. Dispensing is started and at the same time the next label is printed. Conveyor belt speed and print speed have to be synchronized. A reflective sensor monitors the positioning.

Dispensing module	S5104
Material guide	Left aligned
Label width mm	25 - 116
Label height mm	25 - 200
Product surface	Flat
Product height	Fixed
Product during labeling	In motion, speed synchronized with the printer

Mounting equipment SQUIX 4

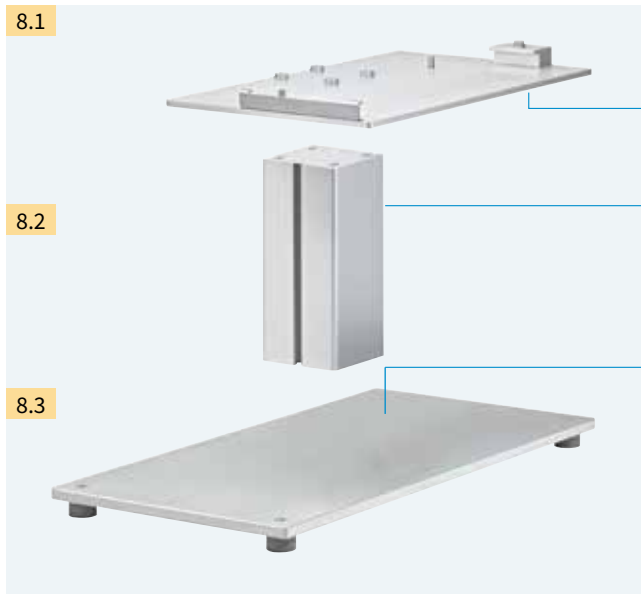

Mounting foot

To fasten the apply system and the product holder

1 Mounting plate

The apply system is fastened on the mounting plate.

2 Profile

Standard lengths 40, 80, 120 mm. The aluminum square profile can be manufactured in further lengths on request.

3 Base plate

To fasten the product holder
Standard size 500 x 255 mm



Floor stand

It enables the printer to be quickly and flexibly integrated in any production line. Height and width of the labeling position are easy to adjust in accordance with the product. Four guide rollers provide for mobility. The floor stand is adjusted with adjustable feet at the place of operation.

Floor stand		1600
Total height	mm	1,600
Labeling height	up to mm	1,400
Projection to center of label	mm	230 - 500
Chassis W x D x H	mm	600 x 860 x 140



Printer holder

The label printer is fixed on the mounting plate and quick-locked.

Software



Label software cablabel S3

It includes three functions:

- design
- print
- monitoring

As regards design, cablabel S3 opens up the full potential of the cab devices. The intuitive user interface provides an extensive instruction set, for example different date formats, mathematical or logic functions.

At this, cablabel S3 connects all cab marking systems. First of all you design your label. Only when it comes to printing you have to decide whether the label shall be dispensed on a label printer, a print and apply system or a marking laser system.

Do you want your marking system to print labels in stand-alone mode? cablabel S3 supports again. After the label has been designed the program supplies all necessary data to be stored within the printer for stand-alone mode.

cablabel S3 is of modular design and can be adapted to your requirements step by step. To support functions like, for example, native programming with JScript, elements like the JScript viewer are embedded as plug-in. The designer user interface and the JScript code are synchronized in real time. Special functions like the Database Connector or barcode testers can be comfortably integrated.

For further information see www.cab.de/en/cablabel

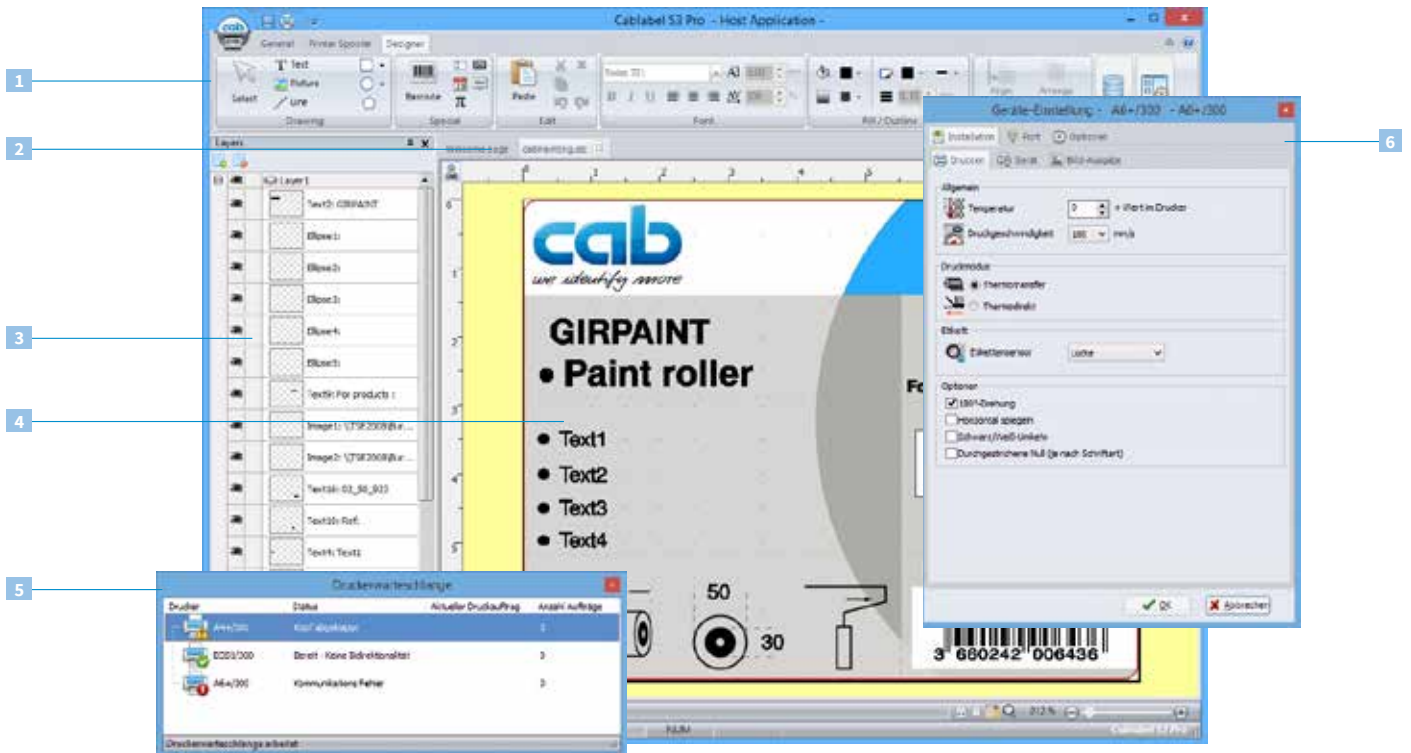

1 Toolbar

Here you can create different objects for your labels.

2 Tabs

For fast navigation between several opened label layouts.

3 Layers

Help to manage different label objects.

4 Designer

Streamlined design by WYSIWYG display of the label.

5 Printer spooler

Monitors all print jobs and shows status of printers.

6 Drivers

With integrated hardware drivers you can manage settings and communication with devices.

Stand-alone operation



This operating mode is the ability of the printer to select and print labels even when the device is not connected to a host system.

The label layout is designed with a label software like the cablabel S3 or via direct programming with a text editor on a PC. Label formats, fonts, texts and graphics as well as database contents are stored and read on a SD memory card, a USB memory stick or the internal data storage IFFS.

Only variable data are sent to the printer via a keyboard, barcode scanner, weighing systems or other host computers. These data are recalled from the host via Database Connector and printed.



Printer drivers

For printer control with a software other than cablabel S3 cab provides drivers in 32/64 bit for operating systems Windows Vista, Mac OS 10.6 (or newer) and Linux with CUPS 1.2.

 **WHQL certified Windows^{®1)} printer drivers**
Our printer drivers are certified and signed by Microsoft. They ensure optimum stability on your Windows operating system.

 **Apple Mac OS X^{®2)} driver**
We provide a CUPS-based printer driver for programs using Mac OS X.

 **Linux drivers**
Linux drivers are based on CUPS.

Printer drivers are available on the DVD delivered with your printer and for free download at www.cab.de/en/support

 **Database Connector**
In stand-alone mode with network connection this program allows the printer to directly access data from a central ODBC- or OLEDB-ready database and have this data printed on the label. Simultaneously with the printing process, data can be rewritten to the database.

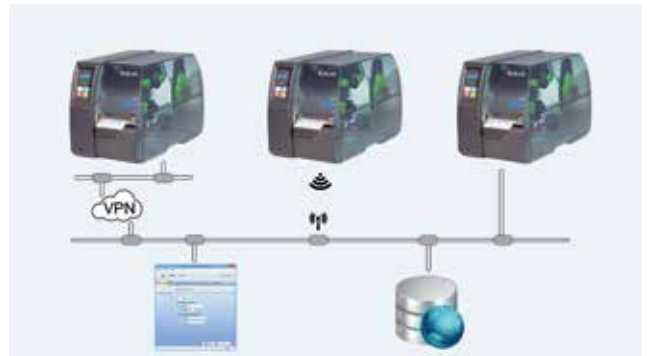

Programming

 **JScript**
To control your printer we have developed the embedded programming language JScript. The programming manual for free download at www.cab.de/en

 **abc Basic Compiler**
In addition to JScript and as an integral firmware element the abc Basic Compiler allows advanced programming of the printer before the data are sent to editing for printout. In this way, for example external printer languages can be replaced without interfering in the current print job. Or you integrate data from other systems like a scale, a barcode scanner or PLC.

Administration

 **Configuration in intranet and Internet**
The HTTP and FTP server integrated in the printer via standard programs like web browser and FTP clients allows printer monitoring and configuration, firmware updates and memory card administration. The SNMP and SMTP client via email or SNMP datagram sends status, warning and error messages to administrators and users. Time and date are synchronized by a time server.



Integration

 **Printer Vendor Program**
As a silver level partner in SAP's Printer Vendor Program cab has developed the replace method allowing easy control of cab printers with SAPScript from SAP R/3. At this, the host system only sends variable data to the printer. Graphics and fonts that priorly have been stored locally (IFFS, SD memory card, etc.) are merged.

Step 1	Step 2	Step 3
Creation of labels and replace file with the cablabel S3 software	Implementation of replace file and replacement of variable data in SAPScript	Printout from SAP

 **Network Manager³⁾**
The Network Manager enables to manage several printers simultaneously within a network. It supports one-stop control, configuration, firmware update, memory card administration, data synchronization and PIN administration.

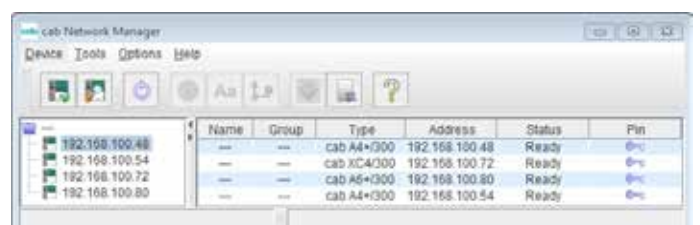

¹⁾ Windows is a registered trademark of Microsoft Corporation.
²⁾ MAC OS X is a registered trademark of Apple Computer, Inc.
³⁾ In preparation

Maintenance



Label sensor

The label sensor is unlocked and pulled out with finger pressure for cleaning.



Print head

The print head can be exchanged in few steps. In general, adjustments and settings are not required.



Print roller

The print roller can be removed with a screw for cleaning or exchange.



Assembling tool

For replacing wear parts or peripheral mounting ONE tool is inserted at the printer ready to hand.

Service



Well-trained cab service engineers give worldwide support in maintenance and repair. Send your printer to a cab service center or a service partner selected by us. Your device will be checked and repaired within few workdays. If requested, a loan device is offered as a replacement during the time of repair.

You want maintenance and repair to be done in your company? Then make an appointment with our service department.

Contact: phone +49 721 6626 300, service.de@cab.de







Training



You enhance your knowledge of cab products for an effective use and gain valuable knowledge for the service and repair of the devices. At the Karlsruhe site, we offer training sessions on handling and operation, label design, software tools, printer drivers, programming, database connectivity, as well as for the integration in networks or a higher-level ERP systems. We will be happy to send you detailed information about the current training offering. Of course we also offer tailored trainings to your individual requirements - in Karlsruhe or at your site.

Product range













Label printers

Pos.		Part no.	Devices
1.1		5977014	Label printer SQUIX 4.3/200
		5977015	Label printer SQUIX 4.3/300
		5977001	Label printer SQUIX 4/300
		5977002	Label printer SQUIX 4/600
1.2		5977016	Label printer SQUIX 4.3/200P
		5977017	Label printer SQUIX 4.3/300P
		5977004	Label printer SQUIX 4/300P
1.3		5977018	Label printer SQUIX 4.3/200M
		5977019	Label printer SQUIX 4.3/300M
		5977010	Label printer SQUIX 4/300M
1.4		5977011	Label printer SQUIX 4/600M
		5977022	Label printer SQUIX 4.3/200MP
		5977023	Label printer SQUIX 4.3/300MP
		5977007	Label printer SQUIX 4/300MP
		5977008	Label printer SQUIX 4/600MP
		Part no.	Special devices
1.5		5977xxx.102	<p>Printer with RFID HF, basic and dispensing version with centered material guide</p> <p>Label printer SQUIX x/xxxM-RFID/HF Label printer SQUIX x/xxxMP-RFID/HF "x" - choose device from Pos. 1.3/1.4</p>
1.6		5977xxx.120	<p>Printer with RFID UHF, basic and dispensing version with centered material guide</p> <p>Label printer SQUIX x/xxxM-RFID/UHF Label printer SQUIX x/xxxMP-RFID/UHF "x" - choose device from Pos. 1.3/1.4</p>
1.7		5977xxx.355	<p>Printer with separator, basic version with centered material guide</p> <p>Label printer SQUIX x/xxxMT "x" - choose device from Pos. 1.3</p>
<p>Scope of delivery: Label printer power cable type E+F, length 1.8 m connecting cable USB, length 1.8 m USB WLAN stick 802.11b/g/n 2.4 GHz operator's manual de/en</p> <p>DVD: Operator's manual in more than 20 languages configuration manual de/en/fr service manual de/en spare parts list de/en programming manual en WHQL certified Windows printer drivers for Windows Vista Server 2003 Windows 7 Server 2008 Windows 8 Server 2008 R2 Windows 8.1 Server 2012 Windows 10 Server 2012 R2 Apple Mac OS X drivers de/en/fr Linux drivers de/en/fr Label software cablabel S3 Lite cablabel S3 Viewer Database Connector</p>			

Wear parts

Pos.		Part no.	Print heads
2.1		5977382.001	Print head 4.3/200
		5977383.001	Print head 4.3/300
		5977444.001	Print head 4/300
		5977380.001	Print head 4/600
		Part no.	Print and rewind assist rollers
2.2		5953700.001	Print roller DR4-M25
		5953701.001	Print roller DR4-M50
		5953702.001	Print roller DR4-M80
		5954180.001	Print roller DR4
		5954183.001	Rewind assist roller RR4
		5954985.001	Print roller DRS4

Accessories

Pos.		Part no.	Extra equipment
2.3		5977339.001	Antistatic brush
2.6		5959622.001	Adapter 100
2.7		5977370	SD memory card 8 GB
2.8		5977730	USB memory stick 8 GB
2.9		5977731	USB WLAN stick 802.11b/g/n 2.4 GHz + a/n/ac 5 GHz
2.10		5977732	USB Bluetooth adapter
2.11		5978911	Barcode tester for linear and 2D barcodes
		Part no.	Dispensing labels
2.12		5977585	Present sensor PS800
2.13		5977538	Present sensor PS900
2.14		5977735	Present sensor PS1000
2.15		5978908.001	Extended peel-off plate DP410
2.16		5978909	Product sensor

Accessories

Pos.		Part no.	Interfaces
3.1		5977369.001	I/O interface
3.2		5917651	I/O interface connector SUB-D 25 pin
3.3		5948205	Label selection - I/O box
		Part no.	Connecting cable
4.1		5550818	Connecting cable RS232 C 9/9 pin, length 3 m
		Part no.	Cutting, perforating, stacking
5.1		5978900	Cutter CU400 with cutter tray
5.2		5978901 5978920	Perforation cutter PCU400/2.5 Perforation cutter PCU400/10
5.3		5978902	Stacker with cutter and base frame ST400
		5xxxxx*	Storage table ST400, label W x H
		Part no.	Rewinding, unwinding labels
6.1		5978903.001	Rewind guide plate RG400
6.2		5978904	External rewinder ER4200
6.3		5978905	External rewinder ER4300
6.4		5978907	External unwinder EU4390
		Part no.	Applicators and dispensing modules
7.1		5976086	Applicator S1000-220
		5976087	Applicator S1000-300
		5976088	Applicator S1000-400
7.2		5949072	Universal tamp pad A1021 70 x 60
		5949075	Universal tamp pad A1021 90 x 90
		59xxxxx* 5977xxx*	Tamp pad A1021 W x H Tamp pad M1021 W x H
7.3		5949076	Universal tamp pad A1321 116 x 102
		5949077	Universal tamp pad A1321 116 x 152
		59xxxxx* 5977xxx*	Tamp pad A1321 W x H Tamp pad M1321 W x H

Pos.		Part no.	Applicators and dispensing modules
7.4		59xxxxx*	Blow pad A2021 W x H
		5977xxx*	Blow pad M2021 W x H
7.5		59xxxxx*	Roll-on pad A1411 W x H
		5977xxx*	Roll-on pad M1411 W x H
7.6		5976084	All-around labeler
7.7		5976085	Applicator S3200
7.8		59xxxxx*	Tamp pad A3200-1100 W x H
		5977xxx*	Tamp pad M3200-1100 W x H
7.9		59xxxxx*	Blow pad A3200-2100 W x H
		5977xxx*	Blow pad M3200-2100 W x H
7.10		5976083	Dispensing module S5104
		Part no.	Mounting equipment
8.1		5978910	Mounting plate
8.2		5958365	Profile 40
		5965929	Profile 80
		5971136	Profile 120
8.3		5961203	Base plate 500 x 255
8.4		5947400	Floor stand 1600
8.5		5978922	Printer holder
		Part no.	Label software
11.7		5588000	cablabel S3 Lite
		5588001	cablabel S3 Pro 1 WS
		5588100	cablabel S3 Pro 5 WS
		5588101	cablabel S3 Pro 10 WS
		5588150	cablabel S3 Pro 1 additional licence
		5588151	cablabel S3 Pro 4 additional licences
		5588152	cablabel S3 Pro 9 additional licences
		5588002	cablabel S3 Print 1 WS
		5588105	cablabel S3 Print 5 WS
		5588106	cablabel S3 Print 10 WS
5588155	cablabel S3 Print 1 additional licence		
5588156	cablabel S3 Print 4 additional licences		
5588157	cablabel S3 Print 9 additional licences		
		In preparation	cablabel S3 Print Server
11.10		9009950	Programming manual en, printed copy

* User specific part no. following request

Product overview

Label printers MACH1/2
in the lower price segment



Label printers MACH4
where little space is available



Label printers EOS1
desktop device for label rolls
up to diameter 155 mm



Label printers EOS4
desktop device for label rolls
up to diameter 210 mm



Label printers A2+
industrial device
up to print width 57 mm



Label printers SQUIX
industrial device
up to print width 108 mm



Label printers A6+
industrial device
up to print width 168 mm



Label printers A8+
industrial device
up to print width 216 mm



Label printers XD4T
for double-sided printing



Label printers XC
for two-color printing



Print and apply systems Hermes+
for automation



Print and apply systems Hermes C
for two-color printing and applying



Print modules PX
to be integrated
in automatic labeling systems



Labels
of more than 400 materials



Ribbons
in wax, resin and resin/wax qualities



Label software cablabel S3
Design, print, monitoring



Label dispensers HS/VS
for horizontal or
vertical dispensing



Labeling heads IXOR
to be integrated
in labeling machines

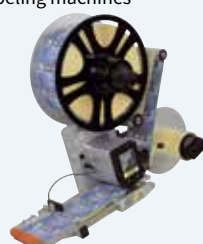

Marking lasers FL+
with output powers 10 to 50 watt



Laser marking systems
for industrial solutions



 Headquarters and fabrication in Germany

 to  International subsidiaries

There are further 820 distribution partners in more than 80 countries.



Europe

Germany

cab Produkttechnik GmbH & Co KG
Wilhelm-Schickard-Str. 14
76131 Karlsruhe
phone +49 721 6626 0
fax +49 721 6626 129
info@cab.de
www.cab.de

France

cab Technologies S.à.r.l.
2a Rue de la Moder
Z.A. Nord du Val de Moder
67350 Niedermodern
phone +33 388 722501
fax +33 388 722502
info.fr@cab.de
www.cab.de/fr

America

USA

cab Technology, Inc.
87 Progress Avenue Unit 1
Tyngsboro, MA 01879
phone +1 978 649 0293
fax +1 978 649 0294
info.us@cab.de
www.cab.de/us

Latin America

Alejandro Balmaceda
Hacienda Jurica Pte 1615
Colonial de Valle
32553 Juárez, Mexico
phone +52 656 682 4301
a.balmaceda@cab.de
www.cab.de/es

Asia

Taiwan

cab Technology Co., Ltd.
希愛比科技股份有限公司
16F-1, No. 700, Jhong Jheng Rd
Junghe, Taipei 23552
phone +886 (02) 8227 3966
fax +886 (02) 8227 3566
info.asia@cab.de
www.cab.de/tw

China

cab (Shanghai) Trading Co., Ltd.
铠博(上海)贸易有限公司
A507, No. 268, Tong Xie Rd
Shanghai 200335
phone +86 (021) 6236 3161
fax +86 (021) 6236 3162
info.cn@cab.de
www.cab.de/cn

cab (Shanghai) Trading Co., Ltd.
铠博(上海)贸易有限公司
Room 39, 10F, 8 Lin He Zhong Rd
Tian He District, Guangzhou 510610
phone +86 (020) 2831 7358
info.cn@cab.de
www.cab.de/cn

Africa

South Africa

cab Technology (Pty) Ltd.
14 Republic Street
Bordeaux
2125 Randburg
phone +27 11 886 3580
fax +27 11 789 3913
info.za@cab.de
www.cab.de/za